

General Information

A secret linen closet door will perfectly hide the entry to your basement, study, man cave, or any other room hidden room.

Our extensive experience and industry leading hardware provides superior concealment, security and quality.

Features

- Pre-hung and tested. No wiring or assembly required.
- Extensive customization options.
- Optional locking system addition. Compatible with our unique secret switches.
- Unlimited phone and video support. Expert advice and support before, during, and after installation.



Available Options

- Style: Freestanding or Built-In
- Wood Species: See "Materials" section
- Finishes: See "Finishes" section
- Sizing: Customizable up to 48"W, 94"T
- Swing Direction: In or Out
- Hinge Side: Left or Right
- Cabinet Doors: Shaker, Slab, Glass Panel
- Crown: Flat or Traditional
- Wireless Switches: Book, Keypad, Fob, etc.
- Power method - Battery or AC wall power
- Automatic Opening Function



Additional Customization

If you require additional customization beyond what is available on our website, please contact us for availability and a no-obligation price quote.



Phone: 480-926-1742

Email: contact@hiddendoorstore.com

Materials

- 
American Hard Maple
 Recommended for painted finishes.
- 
Clear Alder
 Recommended for painted or stained finishes.

Finishes

- 
Unfinished: *Apply your own finish*
 Sanded and ready to accept a finish.
- 
Stained: *Light, Medium, Dark, Match*
 Hand applied stain with sprayed satin topcoat.

Shelf and Door Details

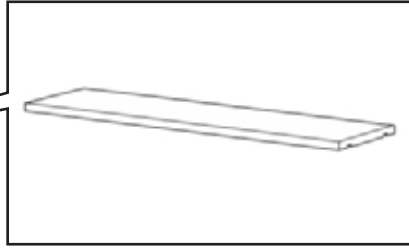
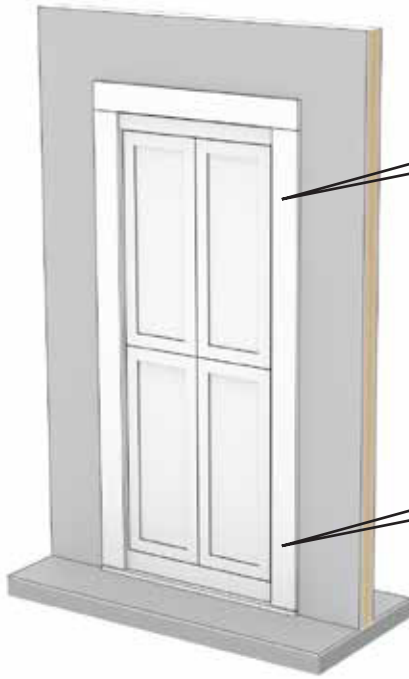

Five flat shelves are provided. Each shelf is 7 1/2" deep. Additional shelving can be ordered upon request.

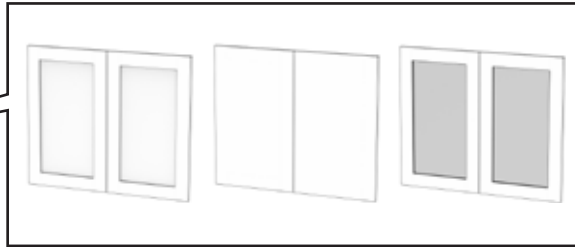

Cabinet doors are available in the following styles: Shaker, Slab, Glass Panel.

Wall Condition Requirements

The door must be installed in a wall opening that is plumb and level. The floor must be a hard surface (IE, concrete, wood, tile) and free of humps or bellies.

It is also recommended to use a level on the face of the wall surrounding the opening and verify that the surfaces are flat.

NOTE: The final quality of the concealment and function of the door depends heavily on the quality of the door opening. For best results, correct any wall or floor issues before beginning your installation.

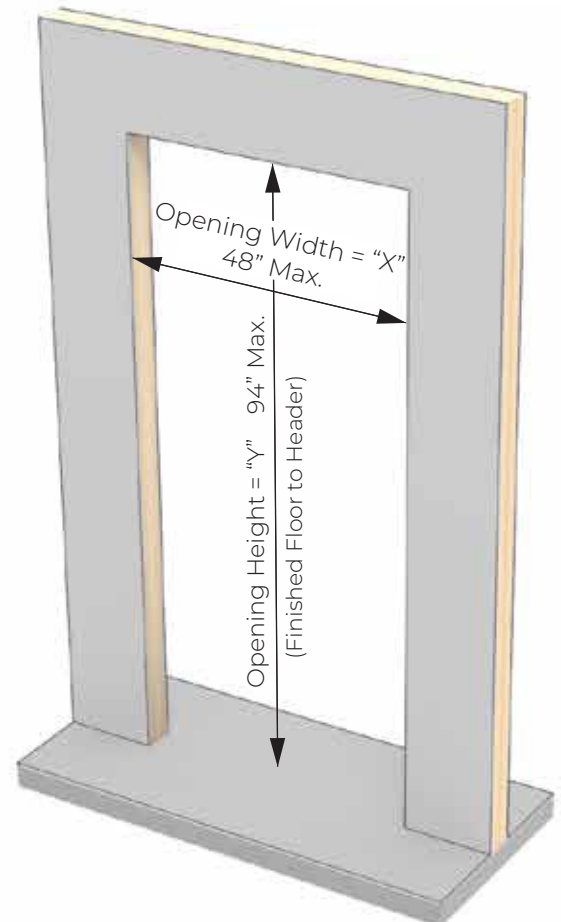

Key Dimensions

Use the charts below to determine the key dimensions of your door based on your chosen wall opening Width and Height.

General Dimensions

"A"	"X" + 1"
"B"	"Y" + .875"
"C"	.75"
"D"	12"
"E"	1"
"F"	"X" - 12.75"
"G"	"X" - 7.5"
"H"	3"
"I"	10"
"J"	"X" - 3.75"
"K"	"X" - 16.75"
"L"	8.25"

Clearance Dimensions

Clear Width (Inswing)	"X" - 17.5"
Clear Width (Outswing)	"X" - 14.25"
Clear Height	"Y" - 4.5"

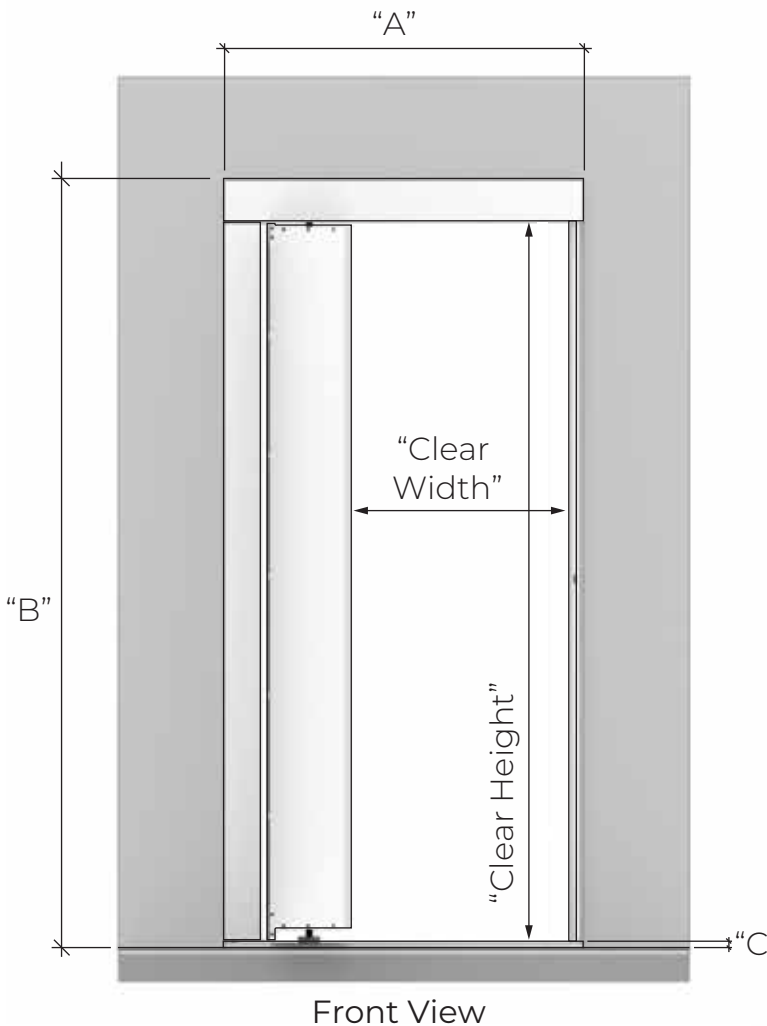
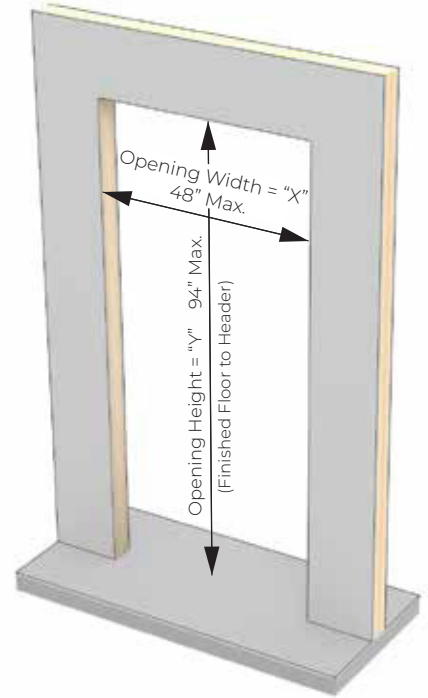

Built-In Style - Top View

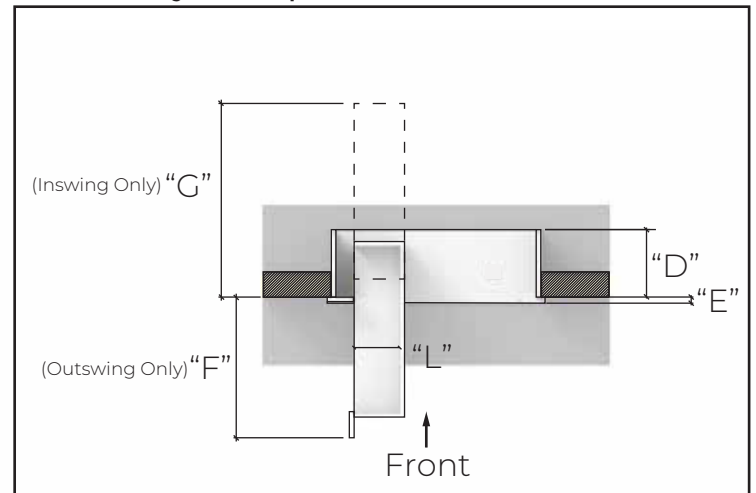

Freestanding Style - Top View

